



TOTAL CONCRETE

Soluciones totales para la construcción

CATALOGO GENERAL

ACABADOS Y
RECUBRIMIENTOS
DECORATIVOS

ADITIVOS PARA
CONCRETO

CONCRETO
INDUSTRIAL

EQUIPOS Y
MAQUINARIA

HERRAMIENTAS Y
ACCESORIOS

IMPERMEABILIZANTES
Y PINTURAS

PISOS Y
ESTAMPADOS

SISTEMA
POLIESTIRENO



TOTAL CONCRETE

ACABADOS Y RECUBRIMIENTOS DECORATIVOS

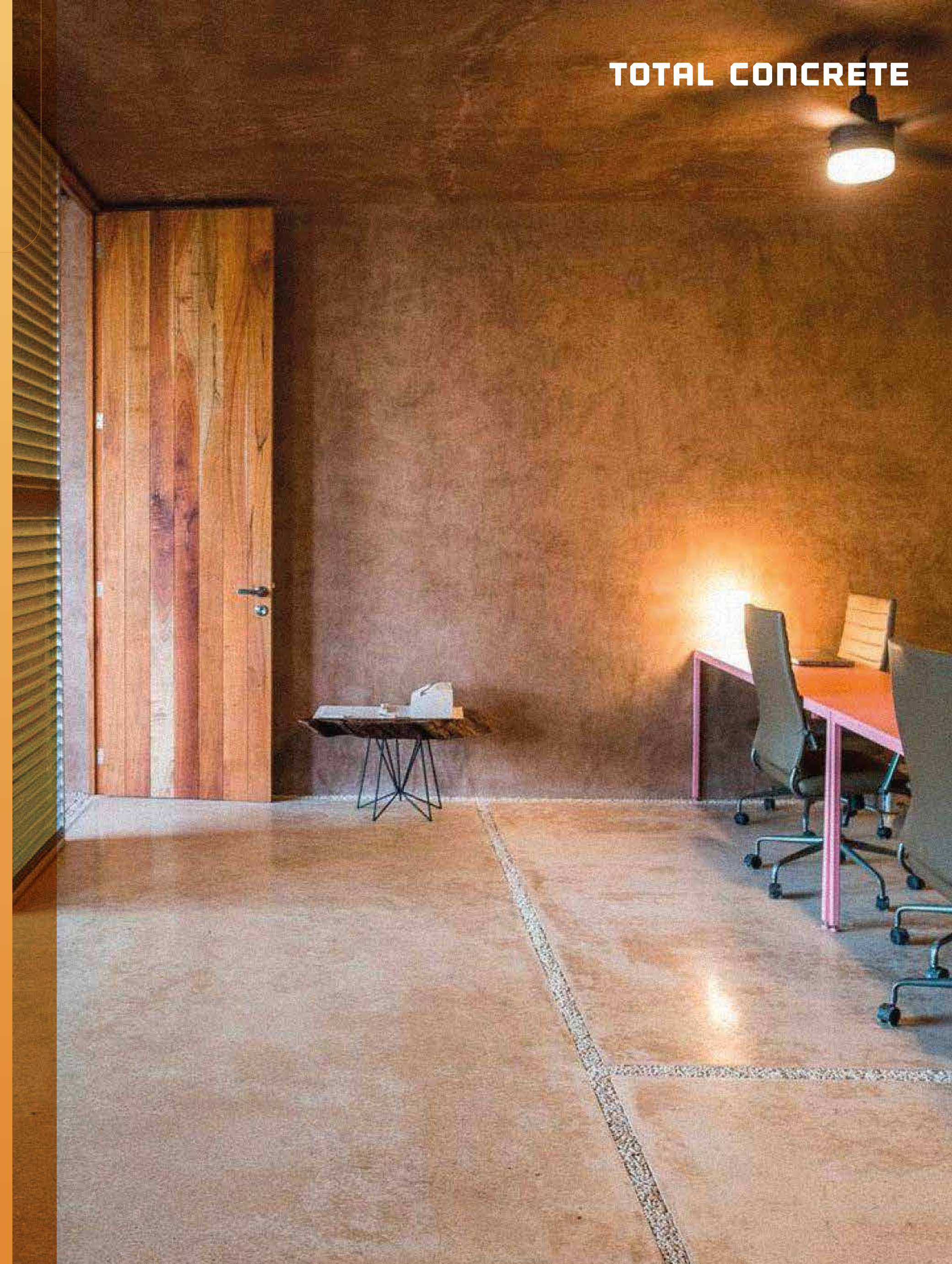



CHUKUM ARTESANAL



RECUBRIMIENTOS TÉRMICOS



MORTERO ARQUITECTÓNICO



MASILLAS



ADHESIVOS



SUSTITUTOS DE SISTEMAS TRADICIONALES



YESO



ADITIVOS PARA CONCRETOS





LÍNEA DE ADITIVOS Y PRODUCTOS PARA CONCRETO



ADHESIVOS PARA CONCRETO



ADITIVOS FRAGUADOS



DESMOLDANTES



MEMBRANAS DE CURADO



CONCRETO INDUSTRIAL

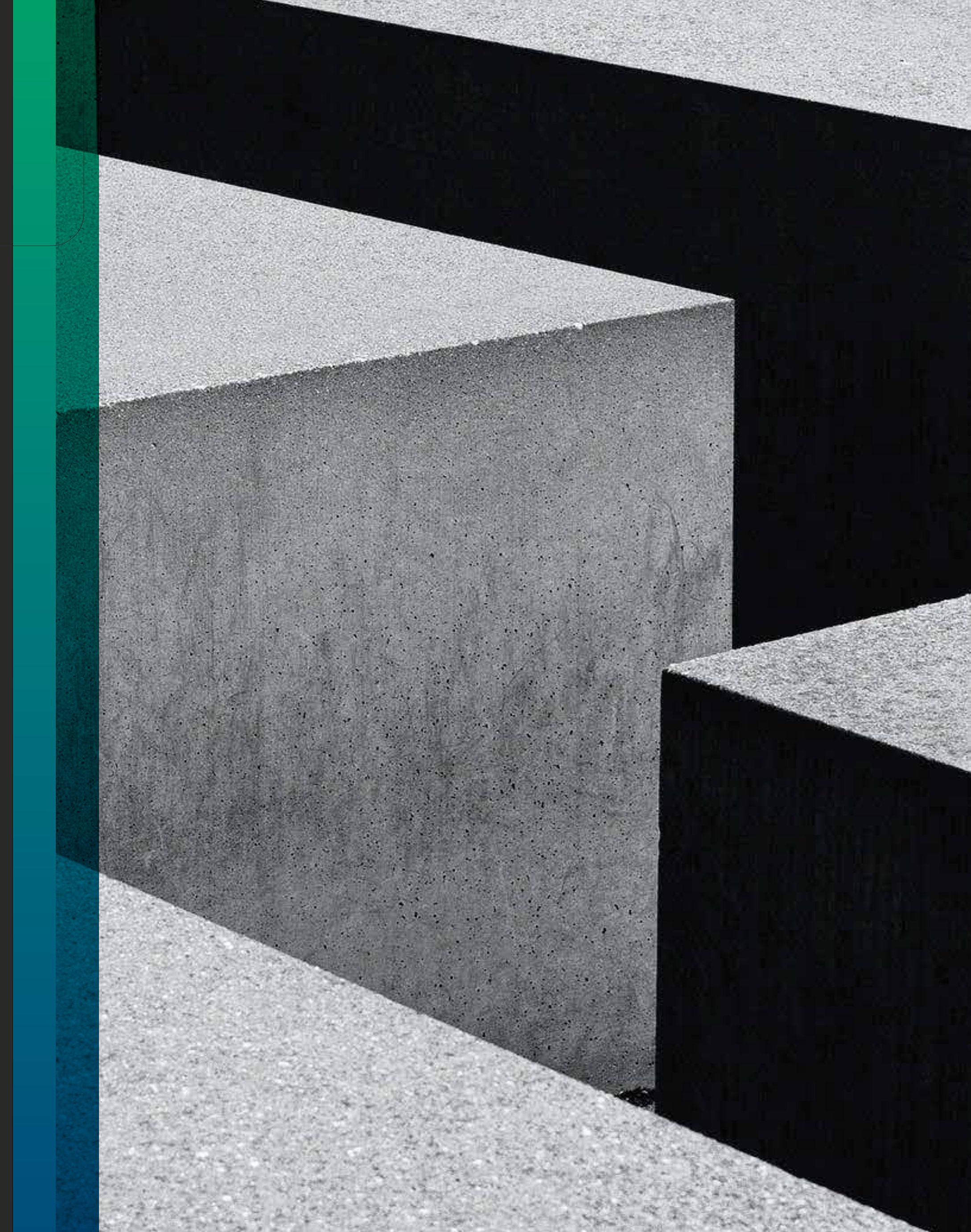

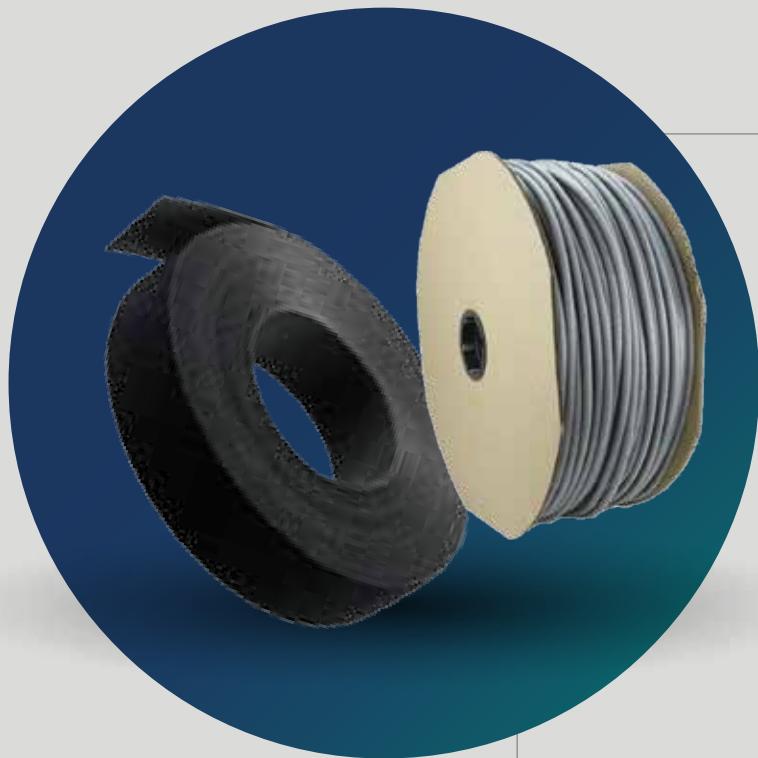

COMPLEMENTO PARA CONCRETO



SELLADOR INDUSTRIAL



WATERSTOP Y BANDAS



MORTERO INDUSTRIAL



MORTERO REPARACIÓN



CATÁLOGO / GENERAL

EQUIPOS Y MAQUINARIA

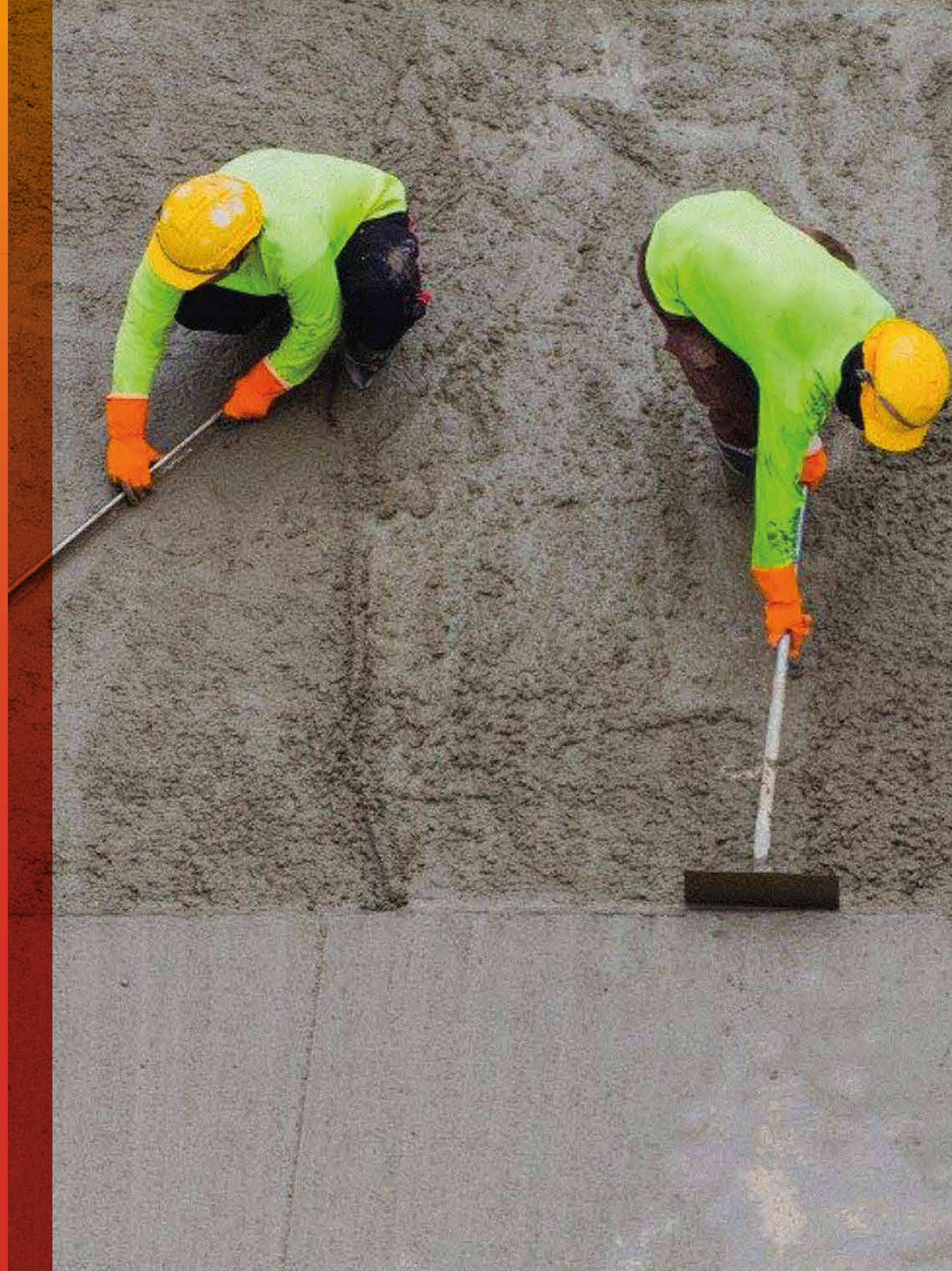



REVOLVEDORA Y CORTADORA



VIBRADOR PARA CONCRETO





CATÁLOGO / GENERAL

HERRAMIENTAS Y ACCESORIOS

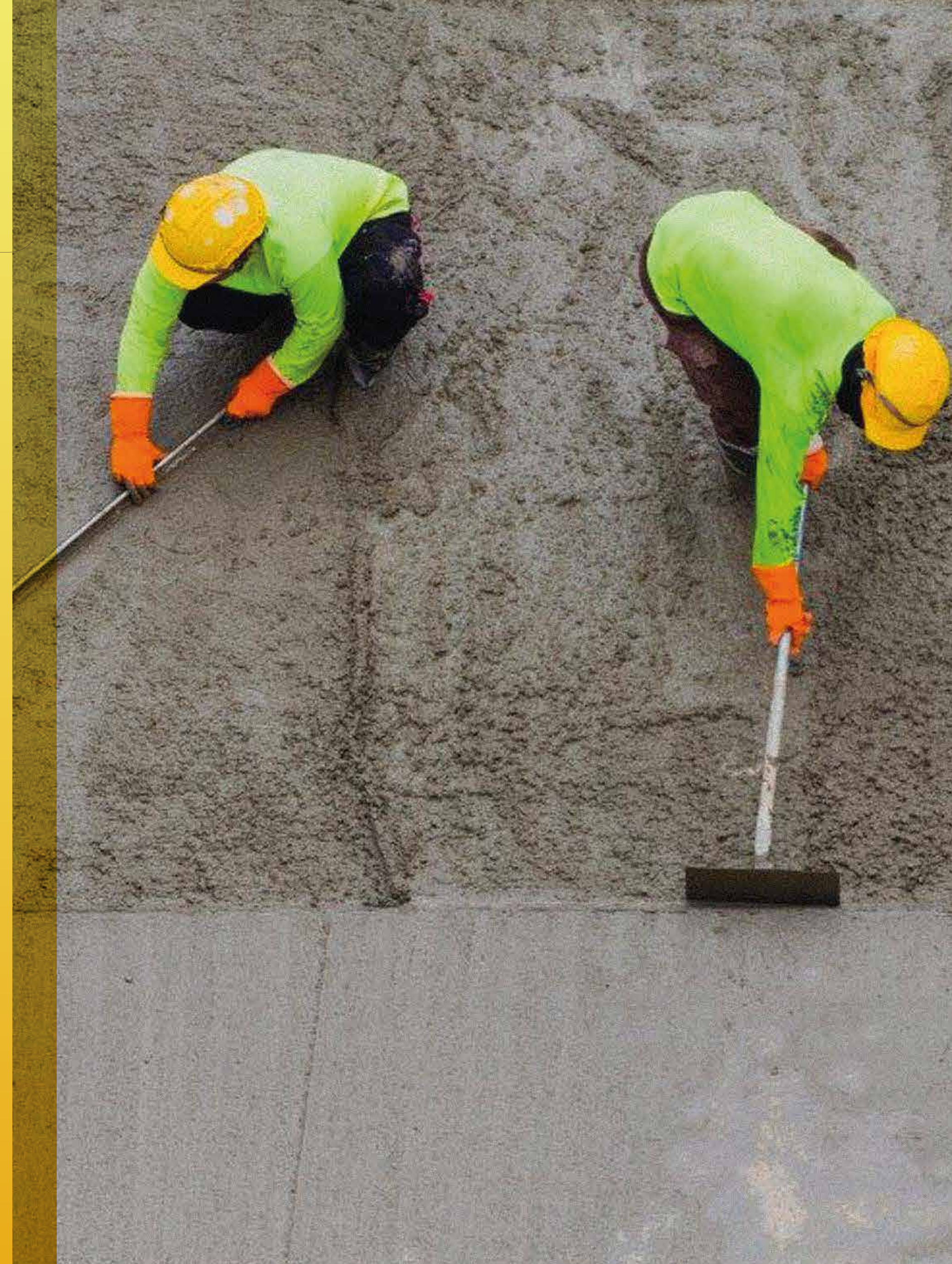



ACCESORIO EPÓXICO

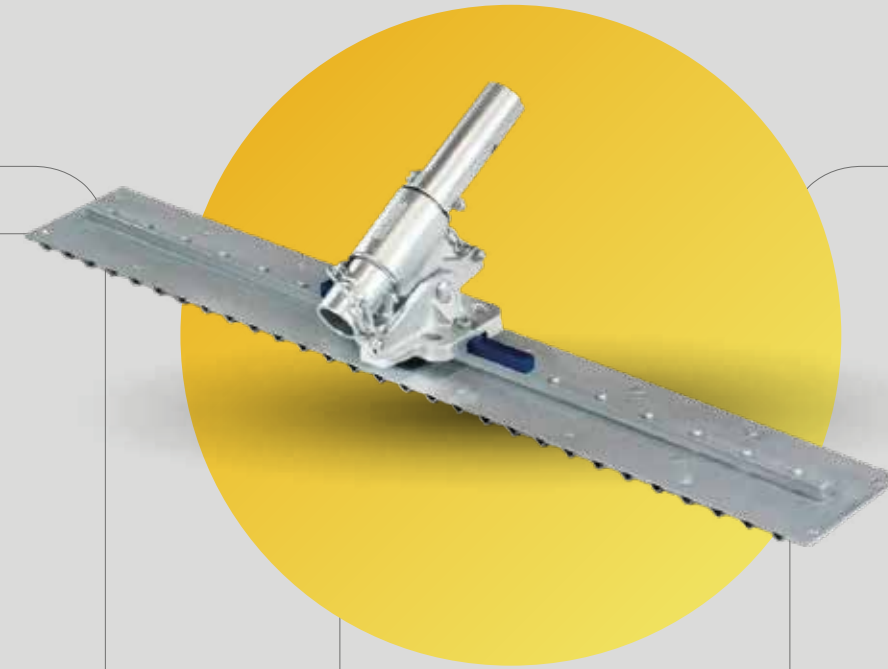

LLANAS



BROCHAS Y RODILLOS



ADAPTADORES



CEPILLOS Y SILICONES



DISCOS DE CORTE



MARTELINAS



PLOMERÍA Y CARPINTERÍA

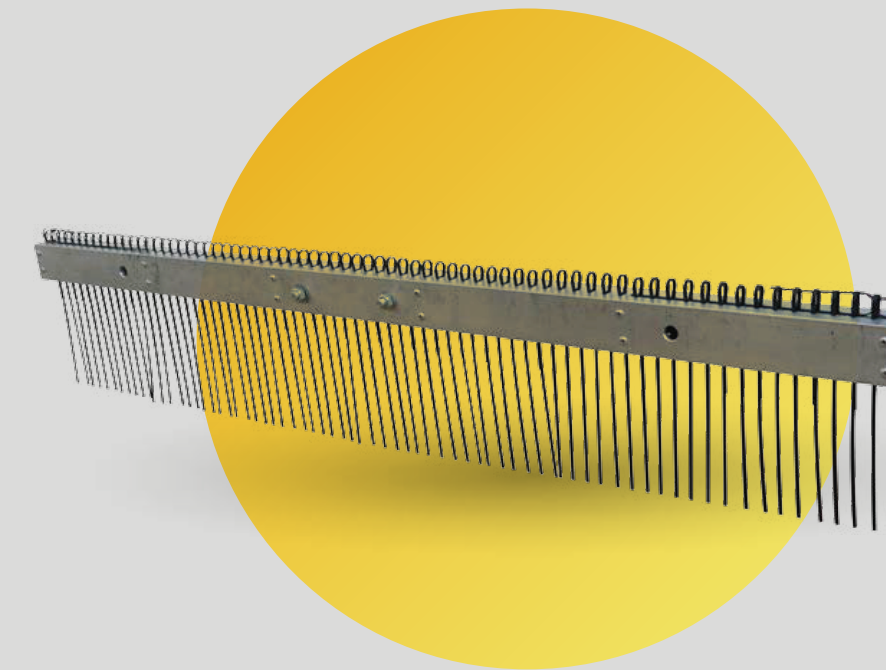

PEINES Y TUBOS



SISTEMAS PARA IMPERMEABILIZAR



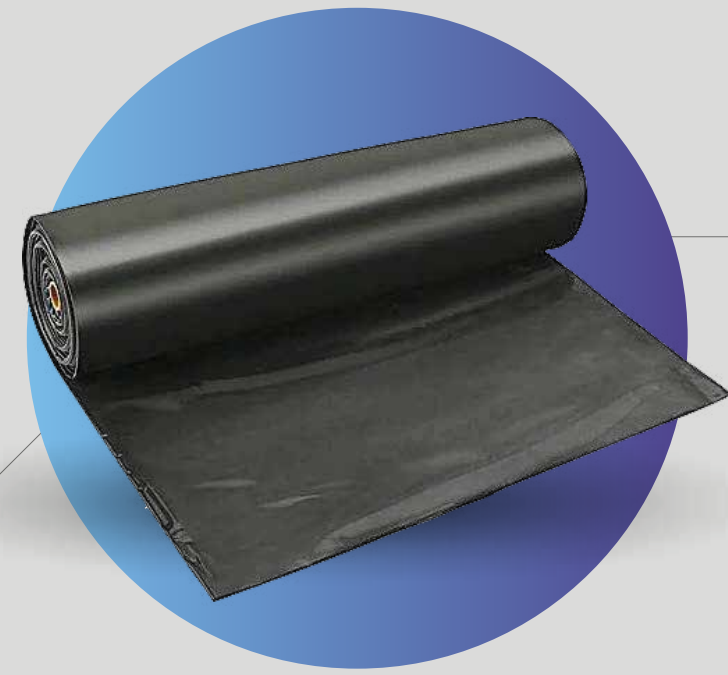

BARRERA DE VAPOR



IMPERMEABILIZANTE ASFÁLTICO BASE SOLVENTE



IMPERMEABILIZANTE FIBRATADO



IMPERMEABILIZANTE INTEGRAL



IMPERMEABILIZANTE ASFÁLTICO BASE AGUA



IMPERMEABILIZANTE ACRÍLICO



IMPERMEABILIZANTE CEMENTOSO



RECUBRIMIENTO ACRÍLICO



MALLAS IMPERMEABILIZANTES



CONCRETOS DECORATIVOS Y ESTAMPADOS





MANTENIMIENTO DE PISOS



ENDURECEDOR PARA PISOS



SELLADORES



PISOS ULTRADELGADOS

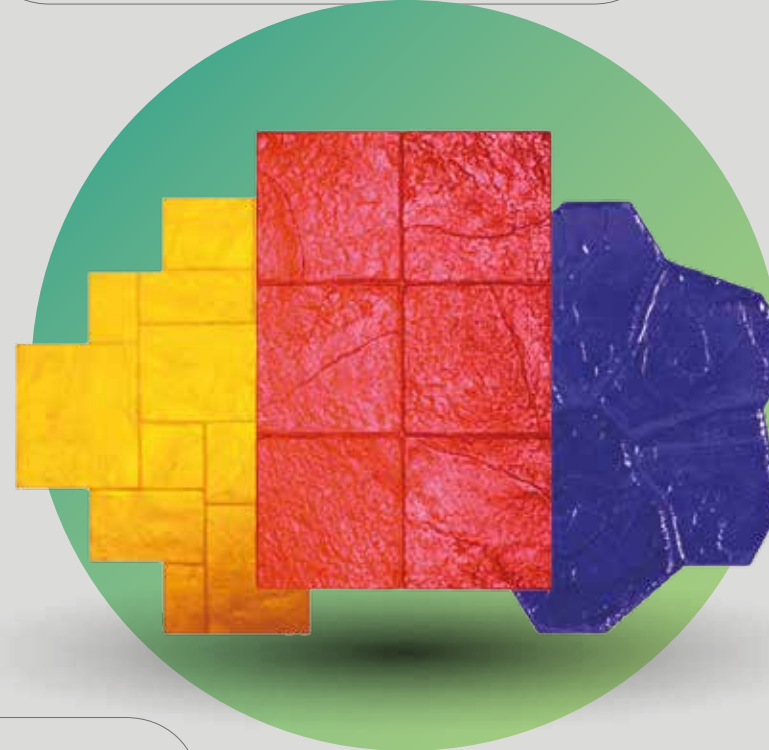

MOLDES PARA ESTAMPADO



SISTEMA POLIESTIRENO





ACABADOS MUROS Y PLAFONES



FIBRA DE VIDRIO

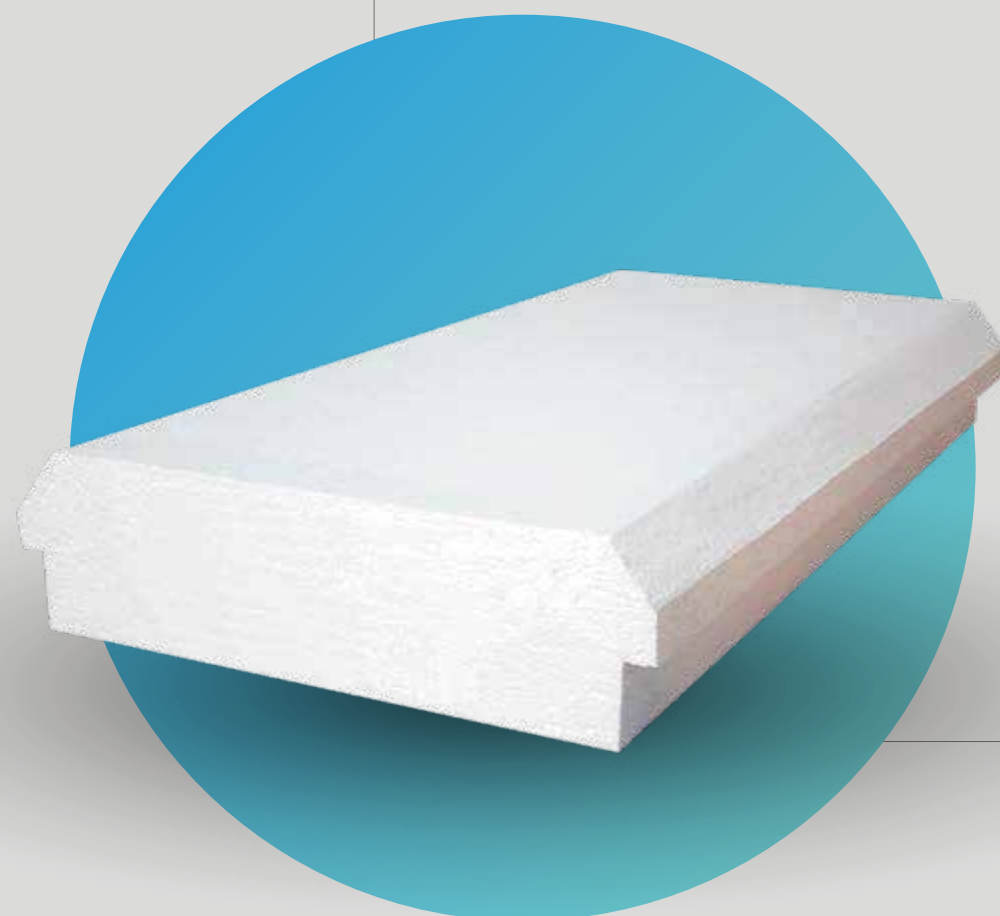

POLIESTIRENO



MALLAS PLAFONERAS